

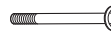











Performance Damper XMAX

Posnr.	QTY	
①	1	
②	1	
③	1	 M8 X 90mm
④	1	 M8
⑤	1	
⑥	2	 M8 X 20mm
⑦	1	 M8
⑧	1	 M8 X 35mm
⑨	1	 M8
⑩	1	 M8
	2	 M8
	1	 M8
⑪	2	 M8
⑫	1	
⑬	1	



Easy, suitable for novice with little experience

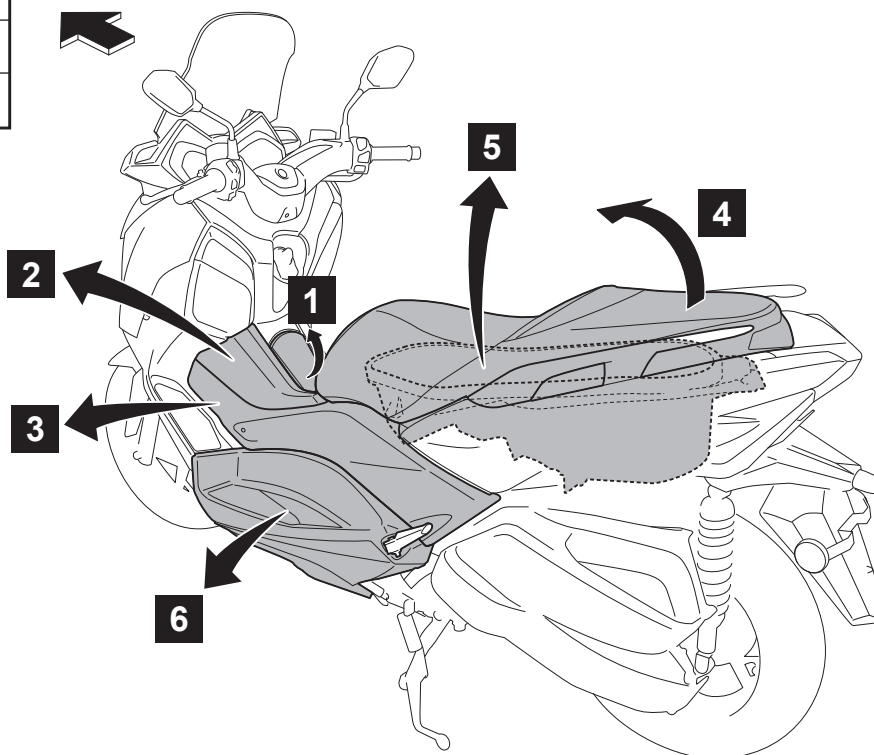
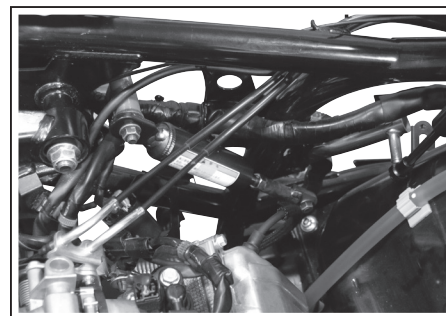

Fairly easy, suitable for beginner with some experience



Fairly difficult, suitable for competent DIY mechanic



Difficult, suitable for experienced DIY mechanic



Very difficult, suitable for expert DIY or professional



Performance Damper XMAX

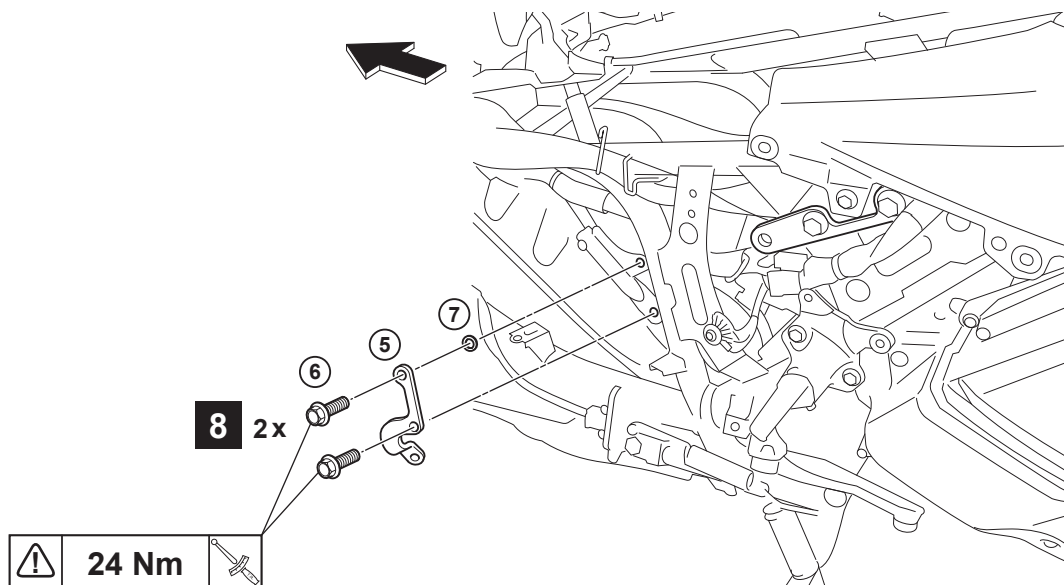
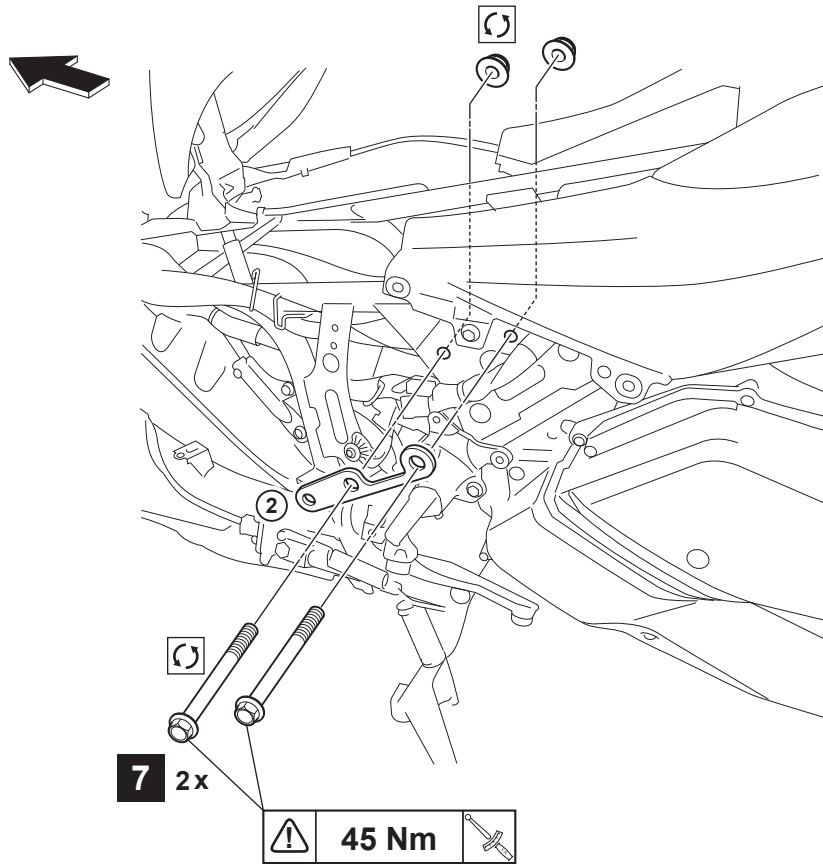

Performance Damper XMAX

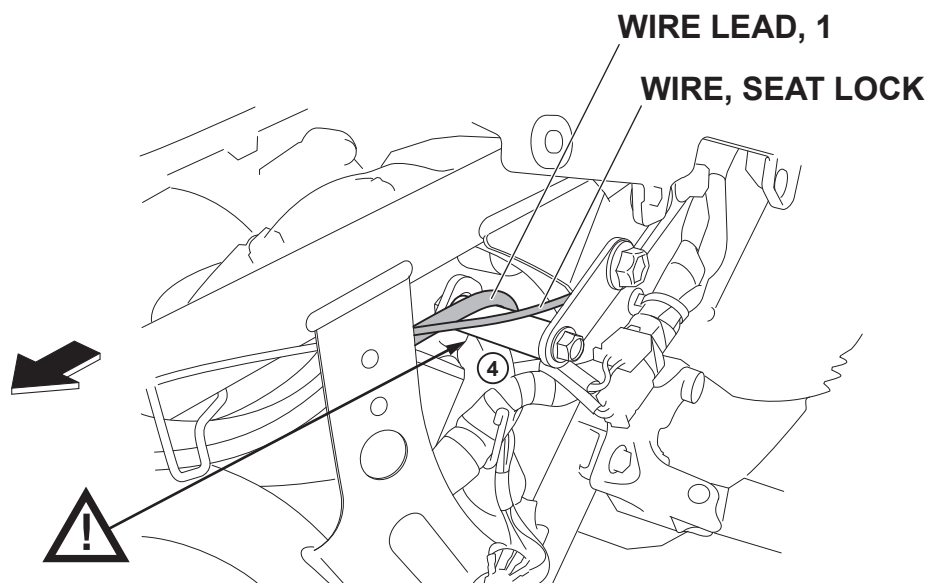
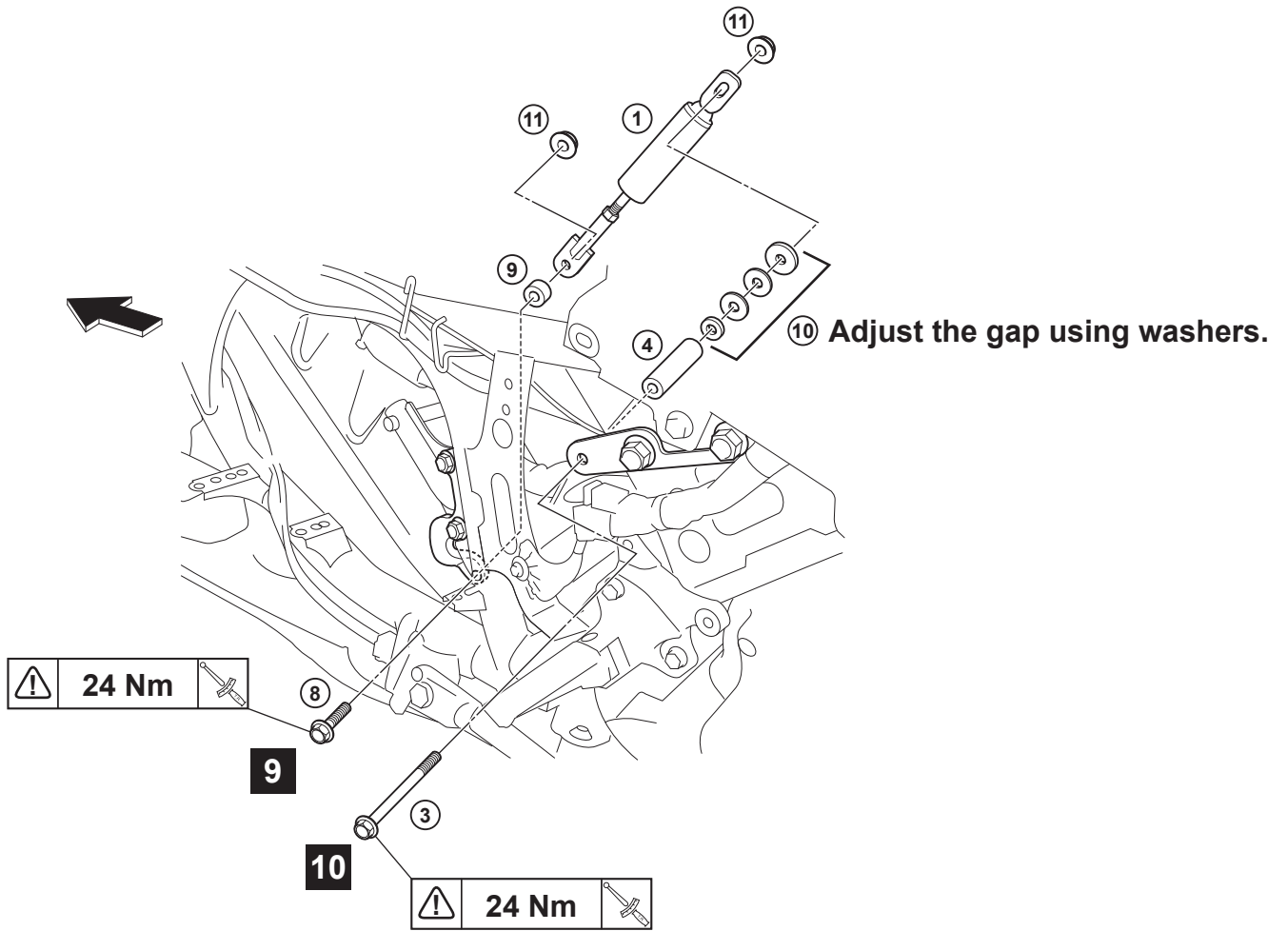

Performance Damper XMAX

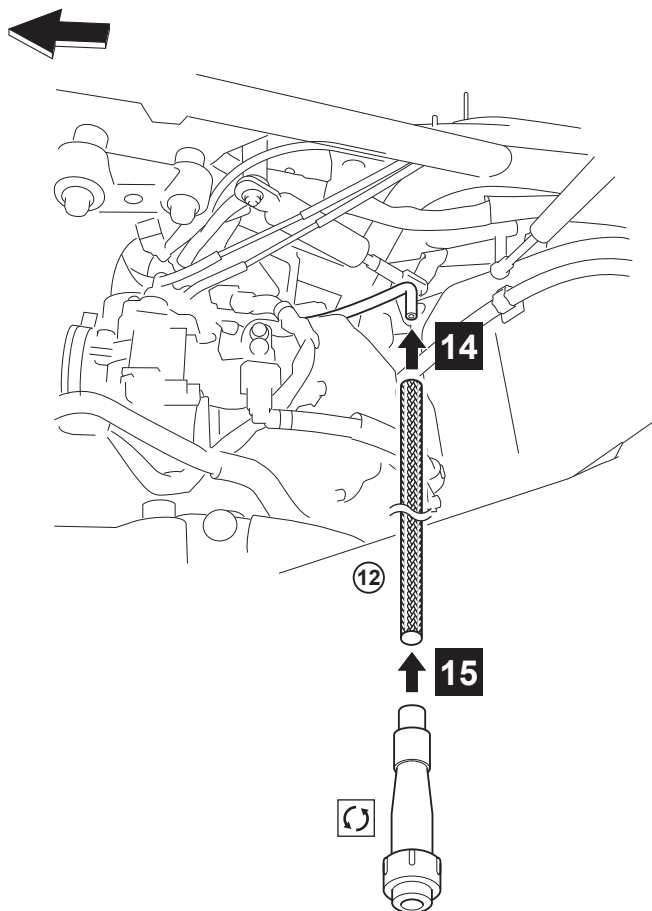
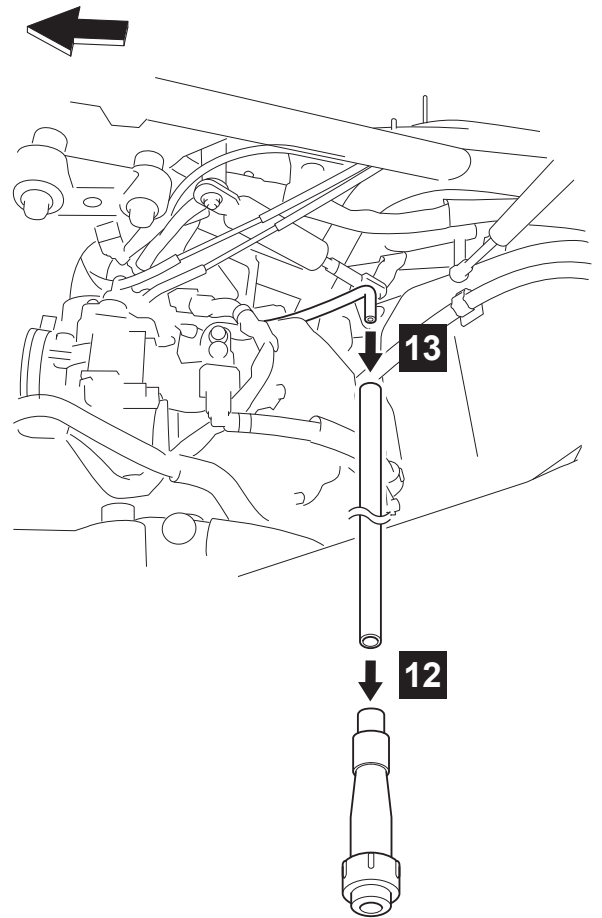
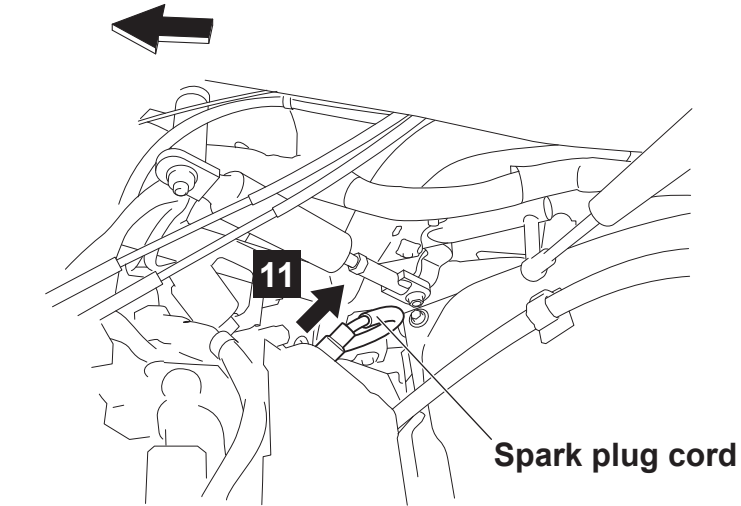

Performance Damper XMAX

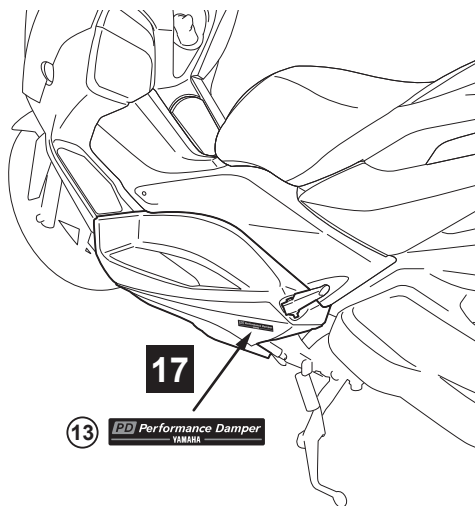
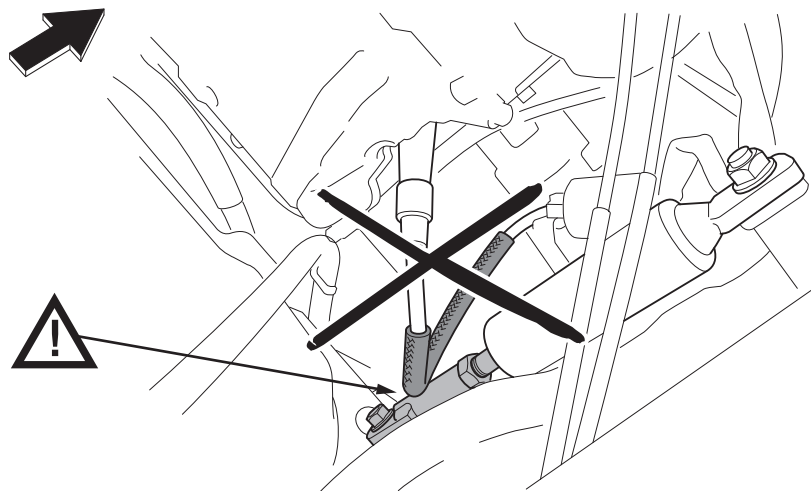
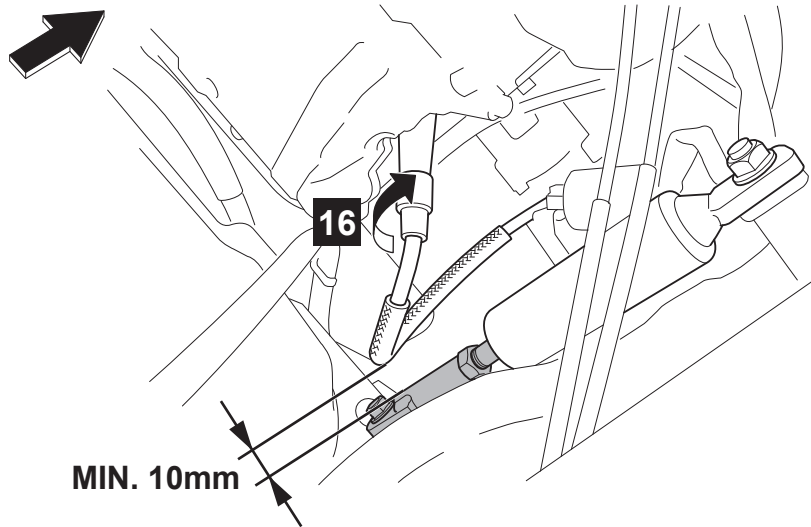

X Do not dent the cylinder

X Do not expand or contract
X Do not rotate the rod

